

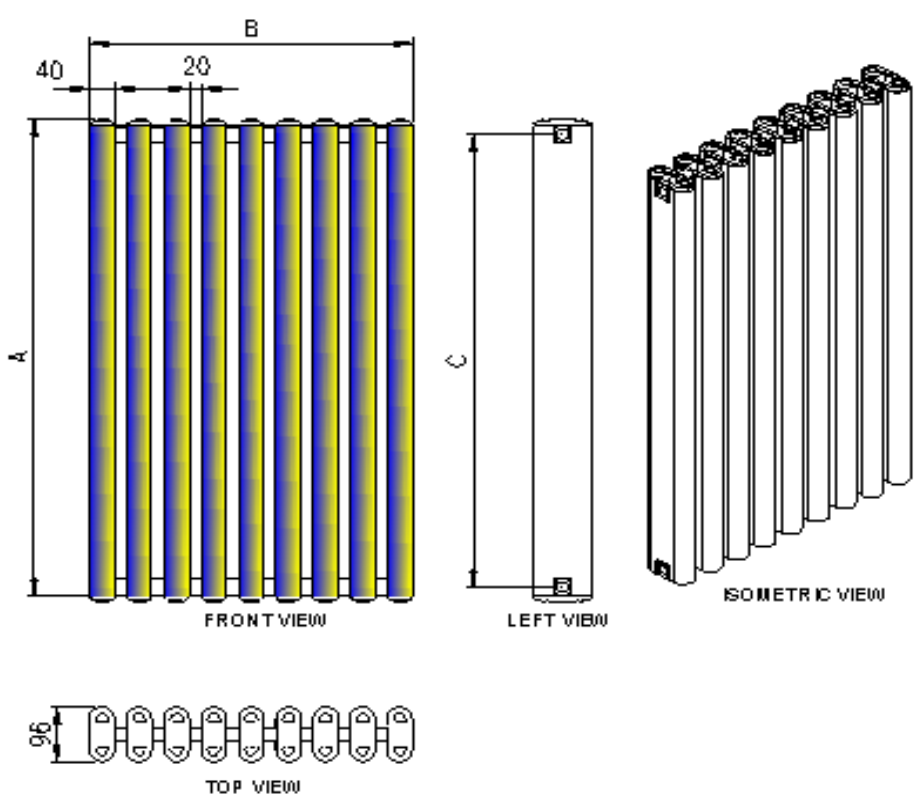









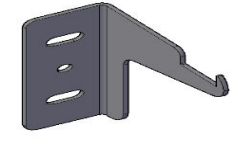
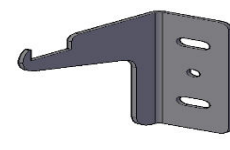

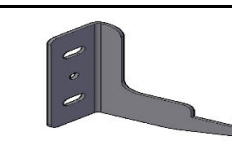
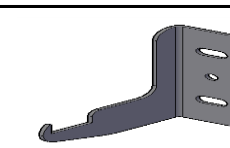

# ALCO INSTALLATION GUIDE

This product must be fitted only by a fully qualified installer.

DESCRIPTION	DESCRIPTION	ILLUSTRATION
 <p><b>RADIATOR x 1</b></p>	<p>Fixing choose the appropriate fixing for the wall material if required</p> <p>PTFE tape</p> <p>Electric drill</p> <p>Masonry drill bit appropriate to the fixings</p> <p>Adjustable spanner</p> <p>Radiator valve hex key</p>	
 <p><b>TOP - RIGHT CLIPS x 1</b></p>	 <p><b>TOP - LEFT CLIPS x 1</b></p>	
 <p><b>BOTTOM - RIGHT CLIPS x 1</b></p>	 <p><b>BOTTOM - LEFT CLIPS x 1</b></p>	
 <p><b>END PLUG x 1</b></p>	 <p><b>FIXING SCREWS x 4</b></p>	 <p><b>WASHERS x 4</b></p>
 <p><b>AIR VENT x 1</b></p>	 <p><b>WALL ANCHORS x 4</b></p>	 <p><b>GASKETS x 4</b></p>
<p>Spirit level</p>		
<p>Measuring tape</p>		

## GENERAL RECOMMENDATION

- Before fitting the radiator it is necessary to wash out the heating system to remove any existing mud, scale, work residues, traces of flux, oil, etc.
- When the system water pH is outside the 5,5-8,5 range and/or when the dissolved is above 0,1mg/liter, it is always needed to protect the heating system components (the radiator is one of these) with a proper chemical treatment compatible with all parts in contact with water (silicon rubber too).
- In order to fit the radiator to the wall, it is necessary to choose the proper fixings for the wall material.
- If the system water exceeds 50°C, please install a warning mark near the radiator to avoid any accidental scalding.
- Clean the radiator surface only with a soft cloth to avoid scratching the finish and do not use chemical againts during cleaning operations. It is prohibited to climb on the radiator.
- Maximum working temperature 95°C, maximum working pressure 4 bar.

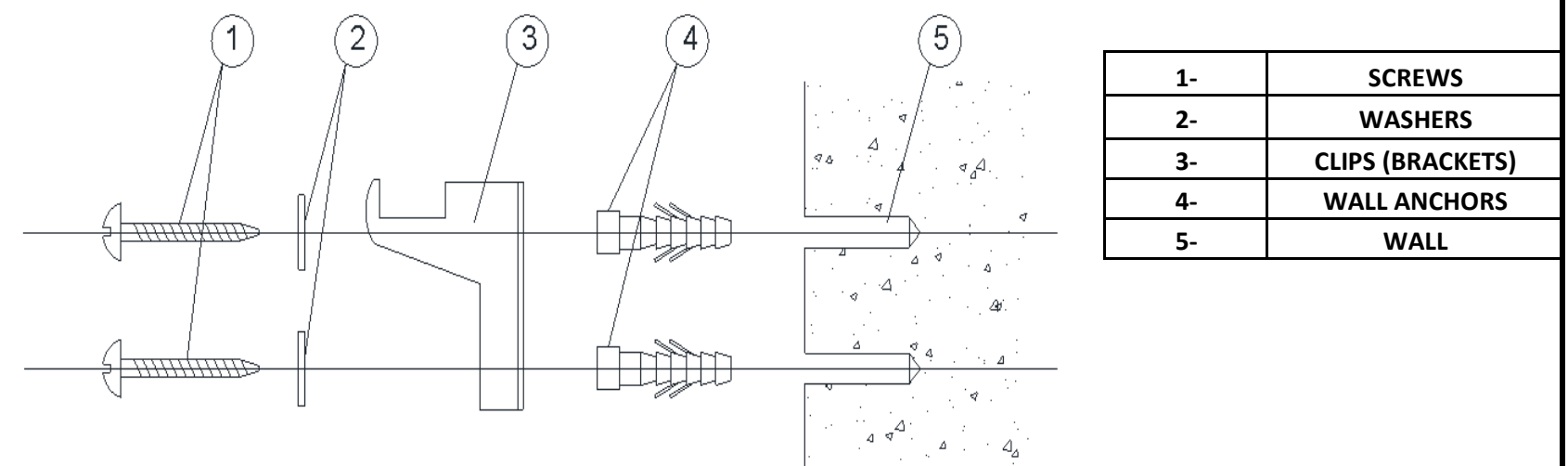

1-	SCREWS
2-	WASHERS
3-	CLIPS (BRACKETS)
4-	WALL ANCHORS
5-	WALL

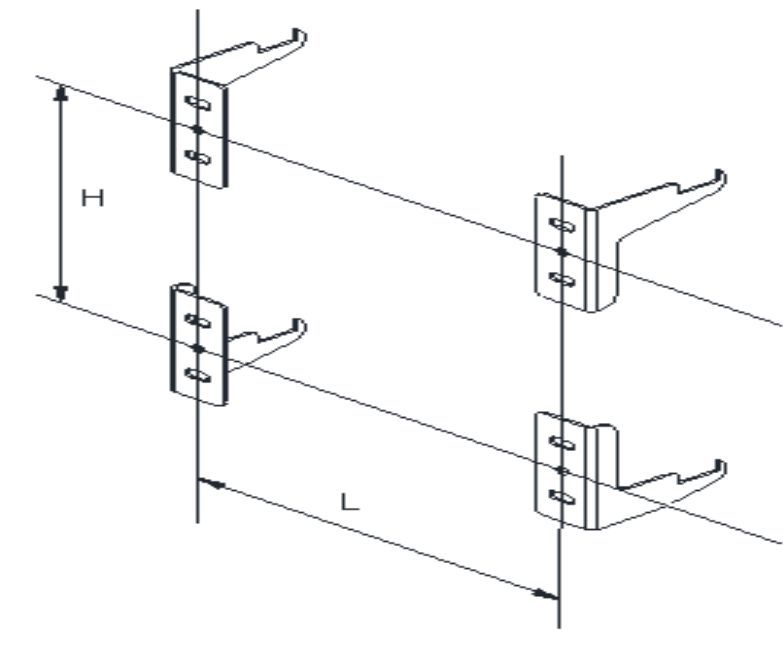
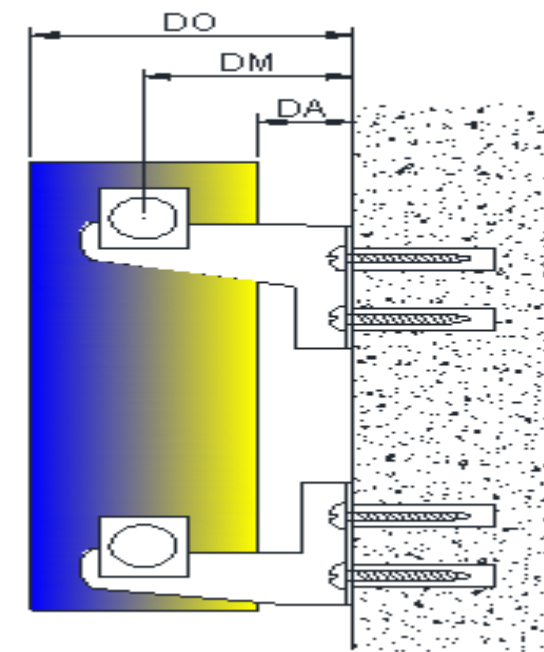

NAMES	A	B	C	TUBE QTY	DA	DM	DO	H	L
ALCO	600	400	545	7	20	68	116	480	142
ALCO	600	580	545	10	20	68	116	480	322
ALCO	600	820	545	14	20	68	116	480	562
ALCO	600	1000	545	17	20	68	116	480	742
ALCO	600	1180	545	20	20	68	116	480	922
ALCO	600	1420	545	24	20	68	116	480	1162
ALCO	1800	280	1745	5	20	68	116	1680	142
ALCO	1800	400	1745	7	20	68	116	1680	142
ALCO	1800	520	1745	9	20	68	116	1680	262